

### Application

Bulk bag (Super Sack) unloading frame - Fork Truck Entry

### Design

3" and 4" x 1/4" wall tubular steel frame with Bulk Bag Lifting Adapter, fully adjustable bag adapter receiver arms (for adjusting to multiple bag sizes in a 30" range at 1" increments), a full bag bottom support pan with agitated "BagShaker" (live bottom) material flow promotion system, an access box for easy and safe spout untying/opening, and heavy 1/2" x 8" square mounting feet with pre-drilled holes for secure anchoring.

ASME B31.1 Structural design per ASME B31.1

#### Controller:

Standard design includes an Allen-Bradley On/Off switch in NEMA 12 J-box. When downstream equipment (feeders, valves, scales, conveyors, etc.) are integrated a NEMA 4 control panel (UL certified) is typically provided.

#### BagShaker Vibrator: (see separate data sheet)

1,500# Max Force, Adjustable force eccentrics, .98 HP, 800 RPM, TENV

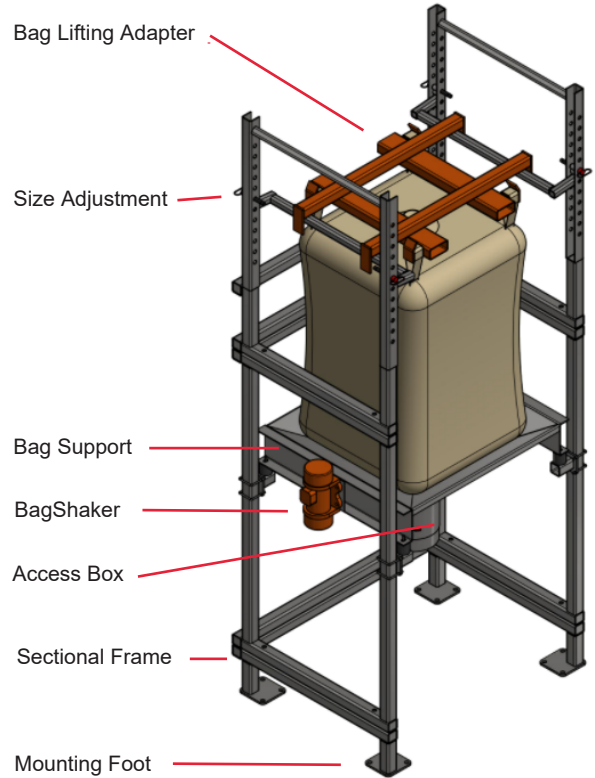

### CUSTOM - CONFIGURATION

Items below are custom designed around application requirements

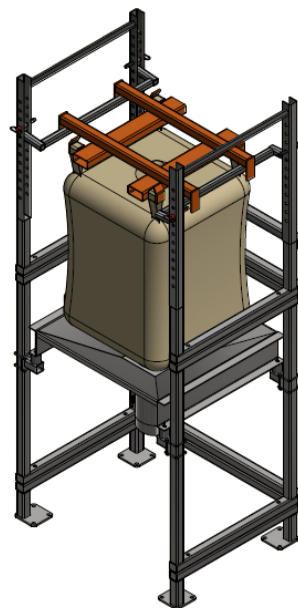
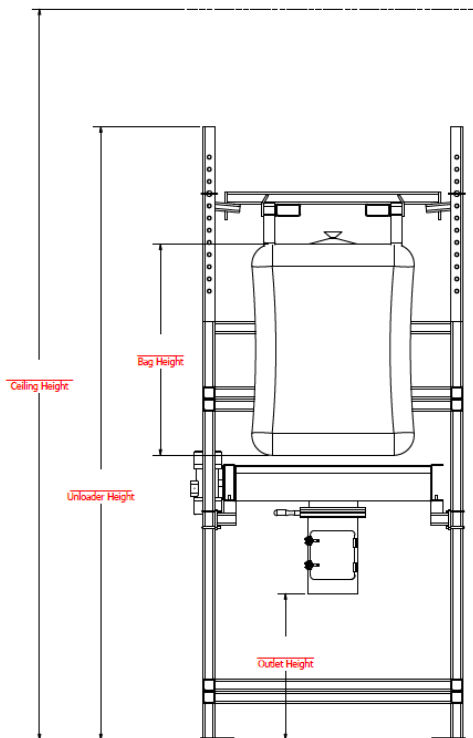

- 3 Phase Voltage**
- 230V - 240V
- 440V - 480V

**Materials:**

Product contact parts: Mild or Stainless Steel (304, 304L, 316, 316L, in mill, bead blasted, 2B, or custom finish

**Painting:**

Standard is Enamel paint light grey RAL 7035  
Optional Epoxy, Steel-It, and any custom color

**Seals:**

PTFE, Neoprene, Silicon





**Temperature-Limits:**

Ambient: 0° - 105°F (-20° - 40°C)



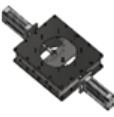



**Explosion Proof (NEC) Options :**

Standard Class II, Div II, Group F&G  
Optional Class I, Div II, Group C&D  
Class I, Div I, Group F&E

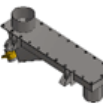
## Options

Iris Valve	Iris valves allow for remote opening of bag spout after untying, metering of material into downstream process, or cutting off flow of material allowing for bag spout retie and bag removal	12" round with 304 stainless steel contacts and aluminum body are standard. 15" and 18" are also available as well as all 304 or 316 stainless steel construction.	
BagChoker Valve	The BagChoker system is an acutated cut off of the bag spout using (2) opposing air cylinder driven C-shaped bar assemblies that require (2) hand operation.	12" 304 stainless steel construction is standard	
Slide Gate Valve	Manual or Acutated Slide Gate Valves allow for metering material flow from system, or cutting off flow completely.	12" x 12" sqaure roller gate with 304 stainless blade and contacts, aluminum body is standard. 4"-20" square or round, in all 304 or 316 stainless steel are available. Typically supplied with support frame and transitions	
Rotary Valve	Motorized Rotary Valves allow for metering material flow from system, or cutting off flow completely. Often used to feed pnematic conveying systems	8" round or sqaure valve in cast steel or 304 stainless are most common, but 6" - 18" units in mild steel, 304 or 316 stainless steel and even CIP (Clean-In-Place) units are available. Typically supplied with support frame and transitions	
Flexible Screw Conveyor	Flexible Screw Conveyors allow for elevating and/or metering material into downstream processes. These include an infeed hopper, UHMW casing (tube), and discharge head with motor & geardrive assembly	4.5" diameter flat wire in 304 stainless steel is most common. Also available in 3" - 8" diameters with round, square, or beveled augurs up to 40' in length. Infeed hopper of 1-50 cubic feet (3.5 -5 standard) and 3HP-15HP 3-phase drives (230-460/3/60). Mild steel, 304 or 316 stainless steel, and even CIP (Clean-In-Place) units are available	
Screw Feeder	Screw Feeders allow for presice metering of material into downstream processes that are typically at low elevation from grade. These include an infeed hopper, metal tube, screw, and motor & geardrive	2", 4", and 6" diameter flat wire in 304 stainless steel is most common. Also available with round, square, or beveled augurs with or without cores. 2HP-5HP 3-phase drives (230-460/3/60). Mild steel, 304 or 316 stainless steel units are available	

**Options - Continued**

Vibratory Feeder	Vibratory feeders allow for precise metering of friable or difficult to handle materials into downstream processes.	12" wide x 24" long tray 304 stainless steel is most common. Also available in tube or enclosed trays as wide as 36" and as long as 20'. Magnetic drives or dual 1HP 3-phase (230-480/3/60) drives. Mild steel, 304 or 316 stainless steel units are available	
Scales	Scales (load cells) allow for weighing and batching of material from bags via metering devices such as slide gate valves, rotary valves, flexible screw conveyors, feeders, etc. and scale controls	(4) 2,500# pancake style load cell assemblies located between the lower sections of the bag unloader frame allow for weighing and gravimetric dispensing, while protecting them from errant fork truck tines	
Bag Break Integrated	Allows for small bags and other containers to be dumped into a shared hopper	5 cubic foot stand alone hopper with 1/2 hinged top with air shocks and offset bulk bag inlet is most common. Available in mild steel coated, or 304 or 316 stainless steel (mill, bead blasted, or 2B finish).	
Surge Hopper	Surge hoppers allow for accumulation of material to allow for changing empty to full bags without starving downstream process. These can also be fitted with a level sensor for low-bag alarm systems	2-50 cubic feet in stand-alone or U-bolted frame arrangements. Available in mild steel coated, or 304 or 316 stainless steel (mill, bead blasted, or 2B finish). Vibrators or agitators are also available	
Conveyors	A myriad of conveyor options exist to transfer material to downstream processes. Selection and integration of these depends widely on material characteristics, rate, density, and other application specific details	Pneumatic vacuum or pressure systems, bucket elevators, belt conveyors, tubular chain or cable-disc systems, drag-chain, and screw conveyors are common	
Control Systems	Control systems are available for integrating additional components (conveyors, feeders, scales, etc.) in a single panel.	NEMA 4 enclosure with E-Stop, component On/Off switches, RiceLake scale controls, Allen-Bradley Micro PLCs, and PowerFlex VFD drives are most common. NEMA 4X as well as air purged or NEMA 7/9 panels are also available	
Bag Piercing Device	Bag piercing device is mounted in receiver hopper of unloader and will pierce the bag open. Allowing the bag to discharge freely.	Heavy-duty angle iron (4) way piercing device with angled mounting feet (pre-drilled for bolt mounting or plain for welding into place)	

**Caution:** measurements are for general reference only. Please consult dimensional drawing for exact measurements